

Gotland E // 170/18

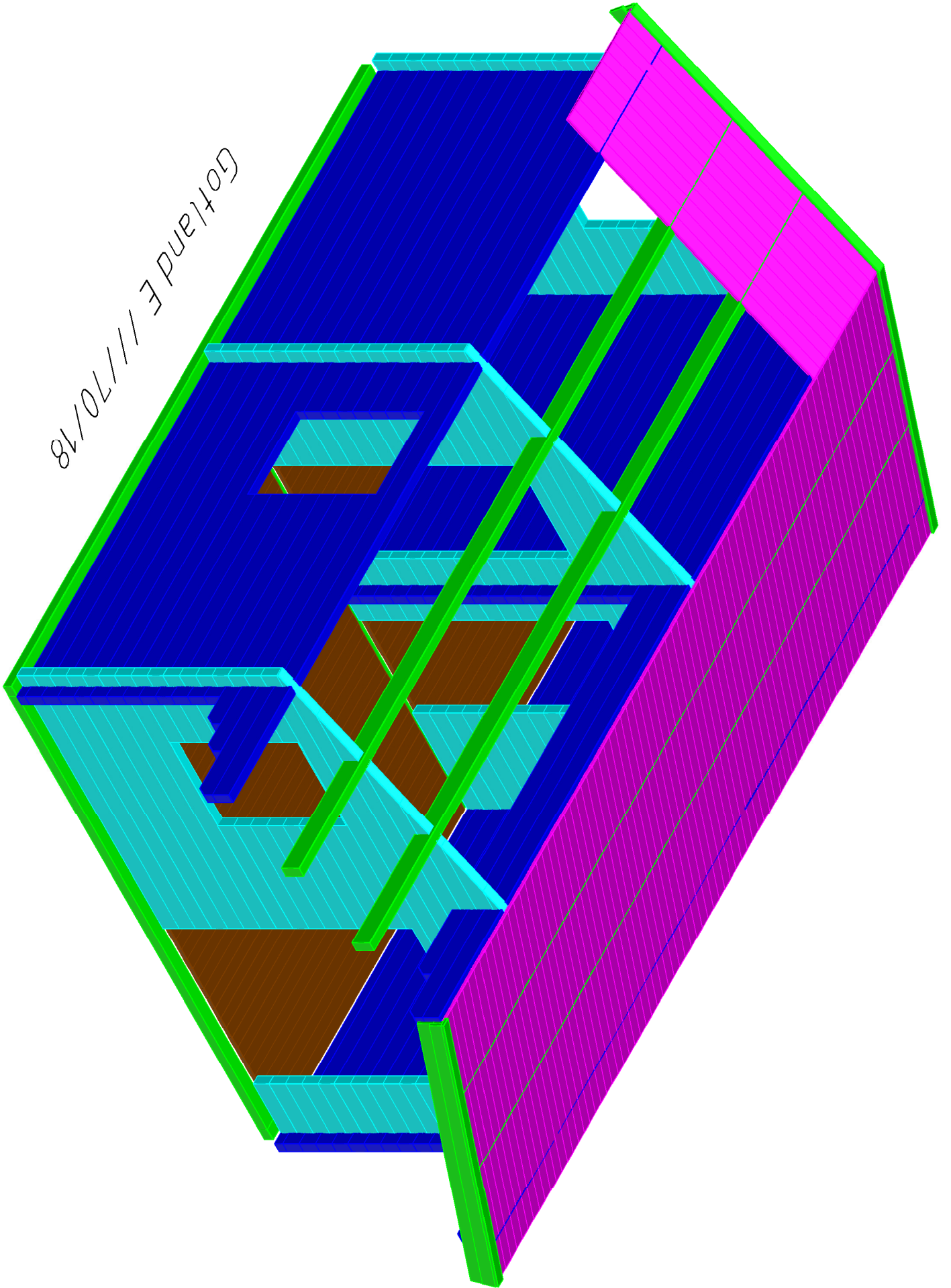

# Gotland E /// 70/18

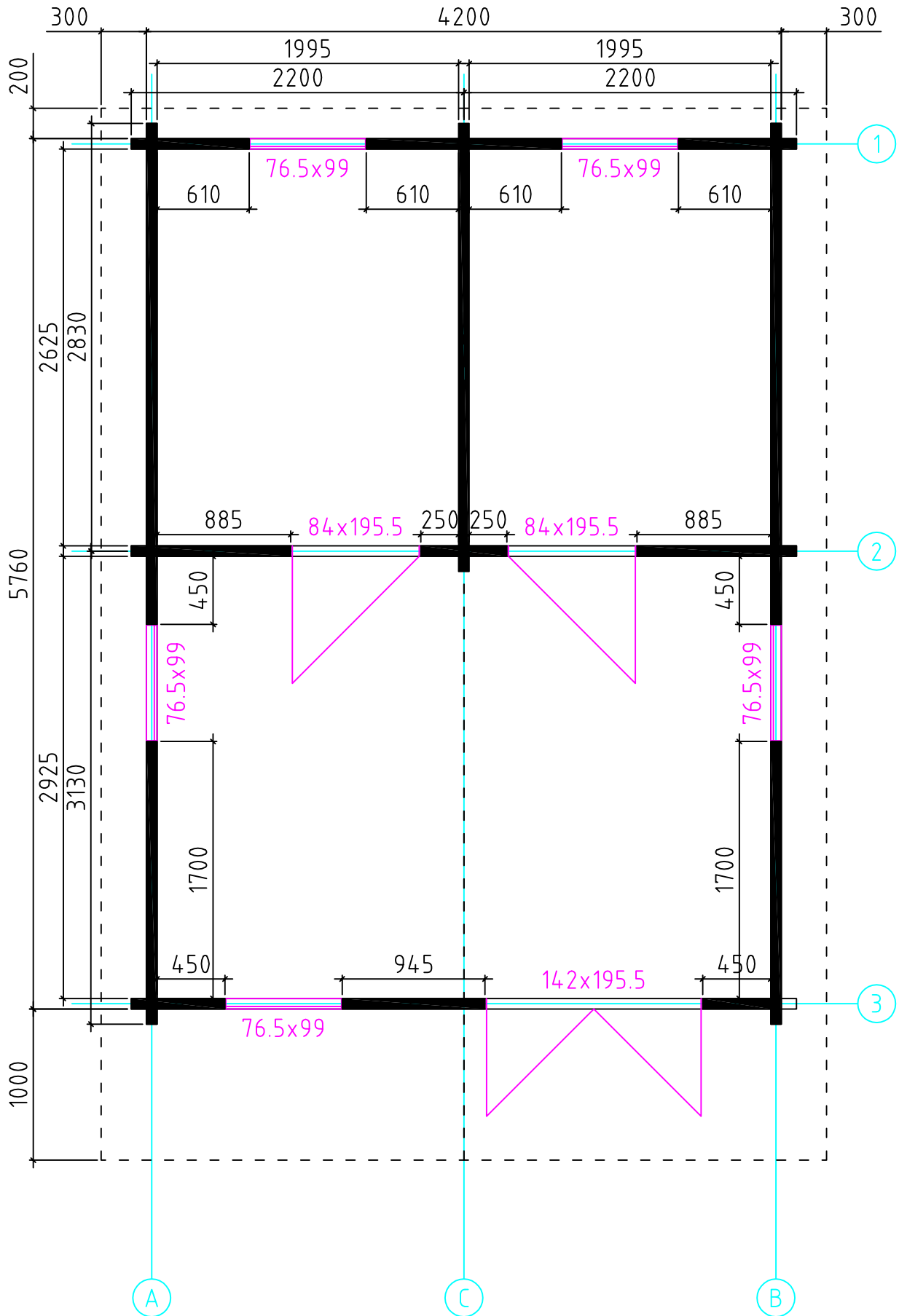

Grundplan

Gotland E ///70/18

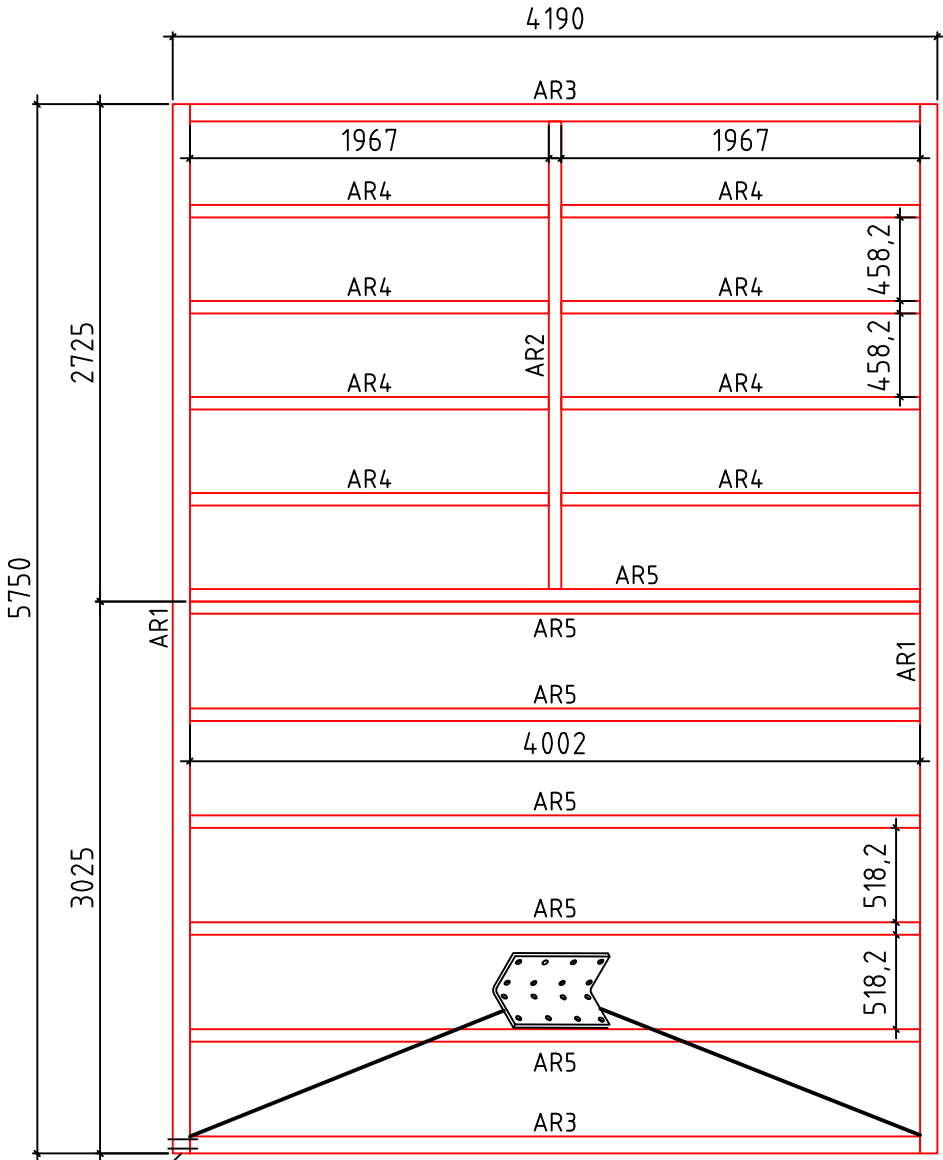

Schrauben  
6x130 

Fundament

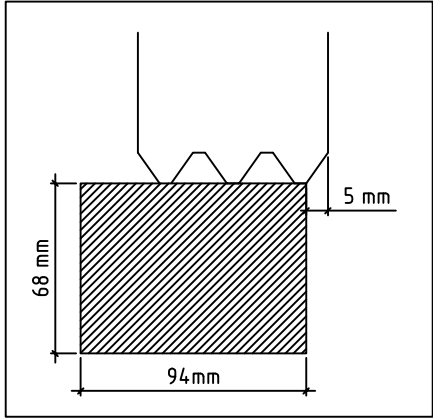

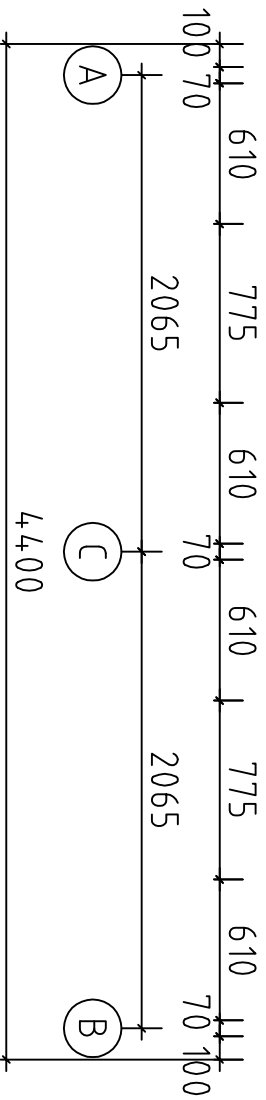
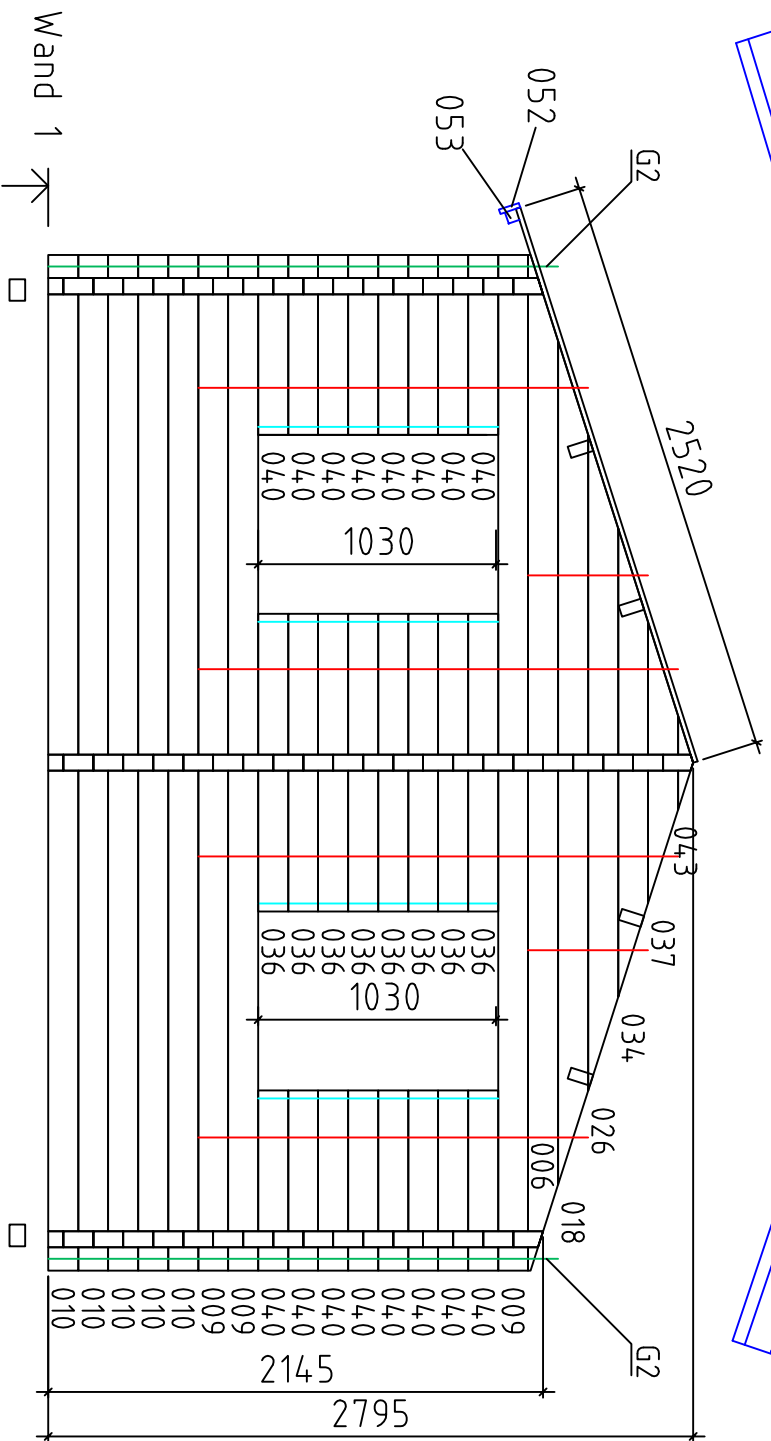
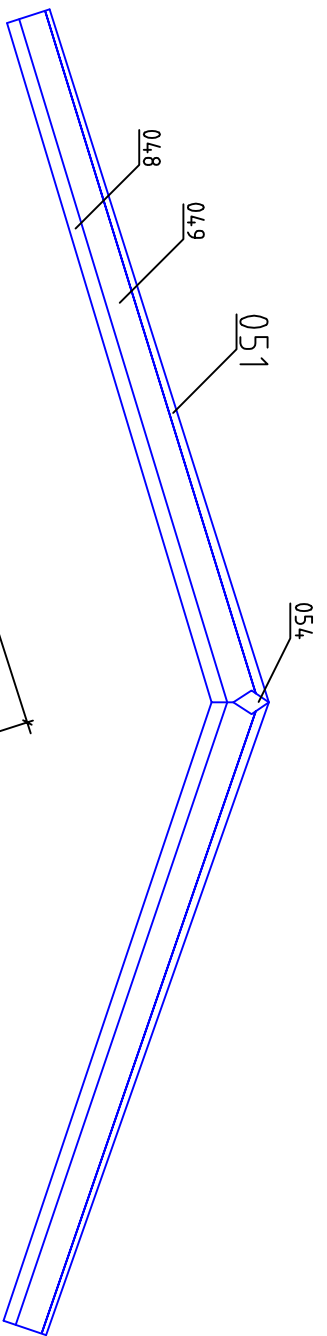
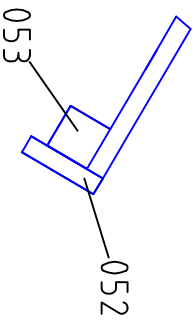
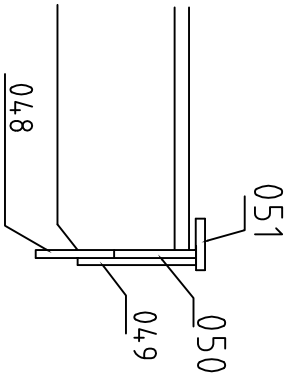

Gotland E // 70/18

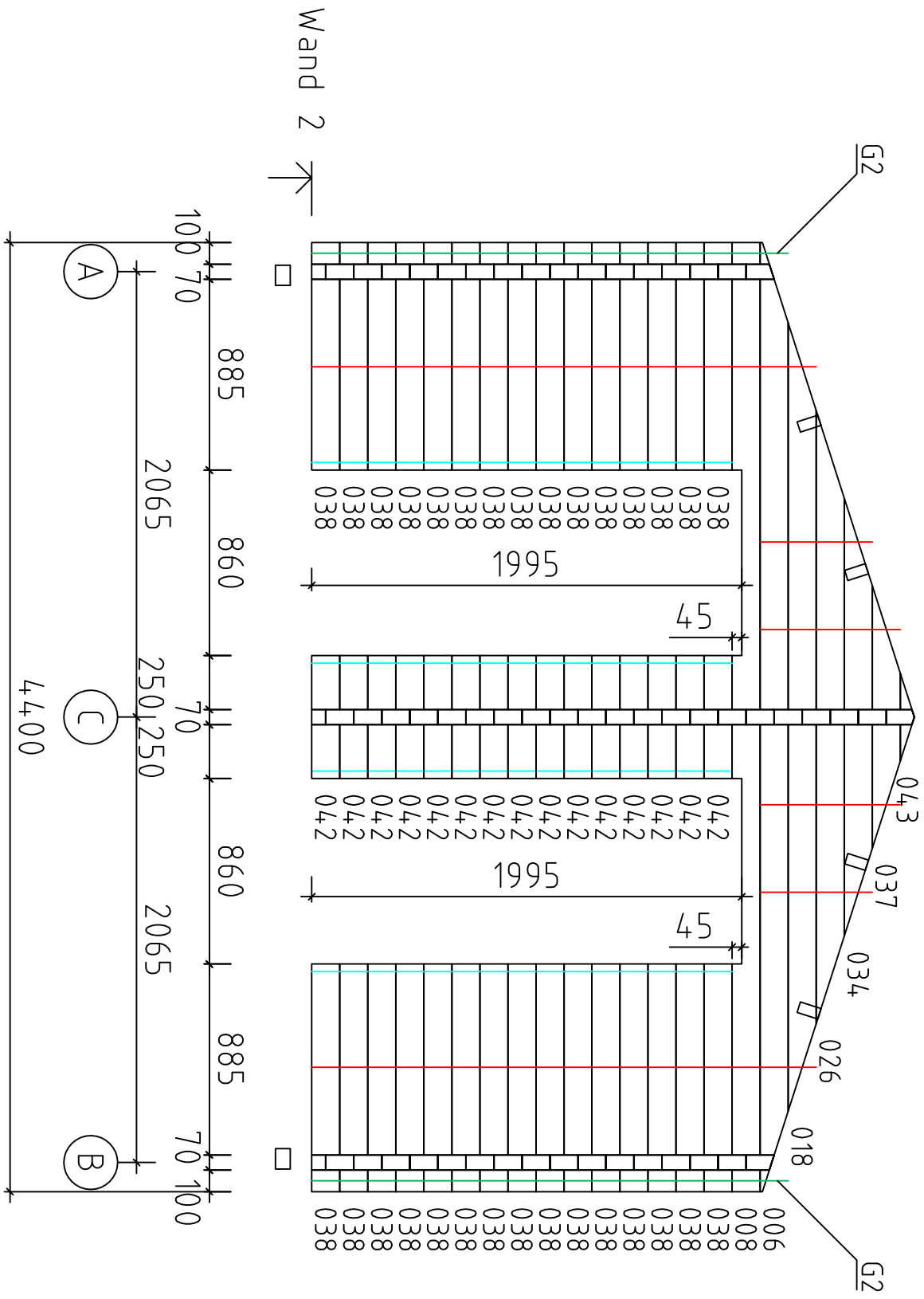

Gotland E // / 70 / 18

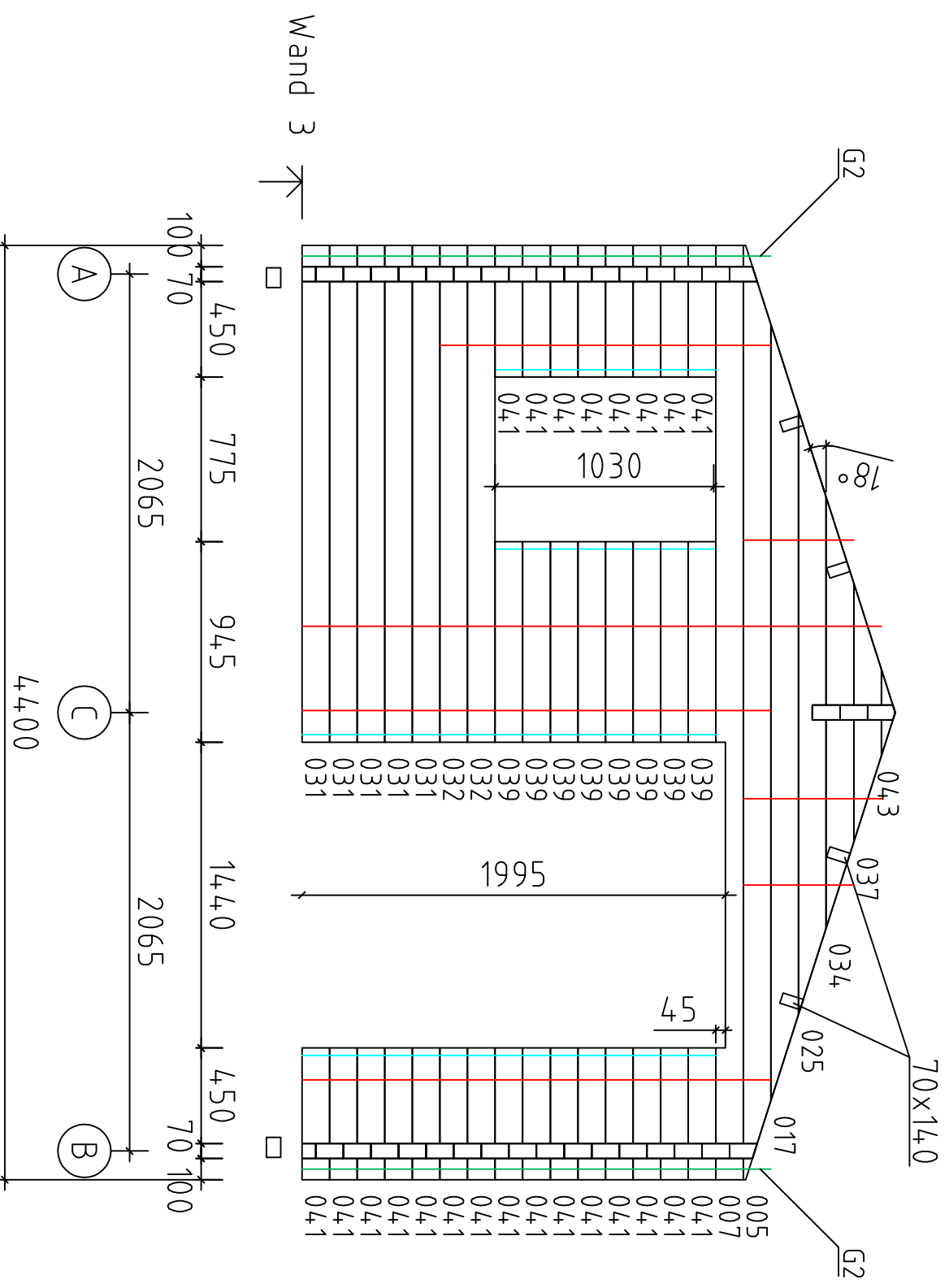

Gotland E // / 70 / 18

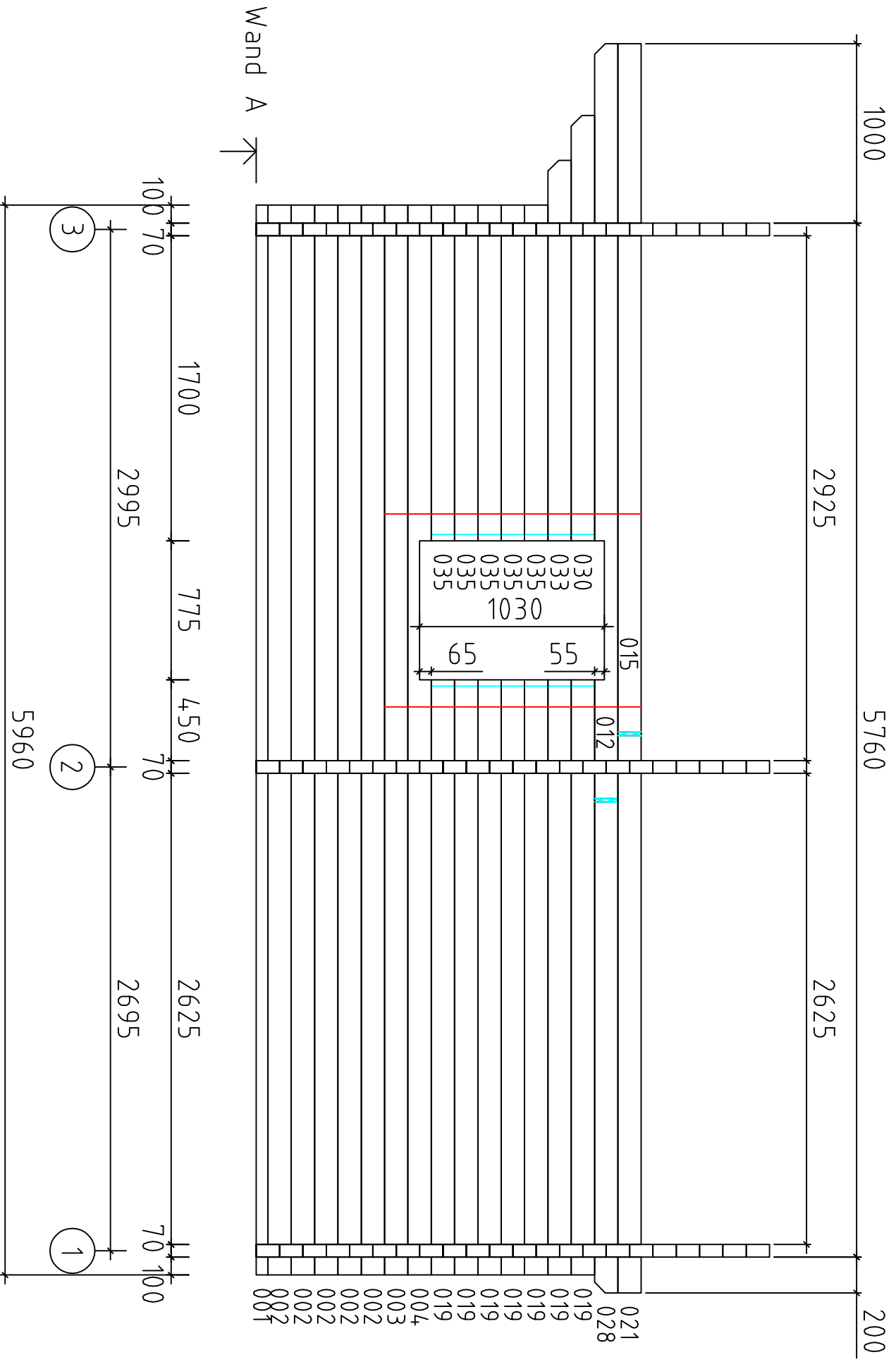

# Gotland E /// 70 / 18

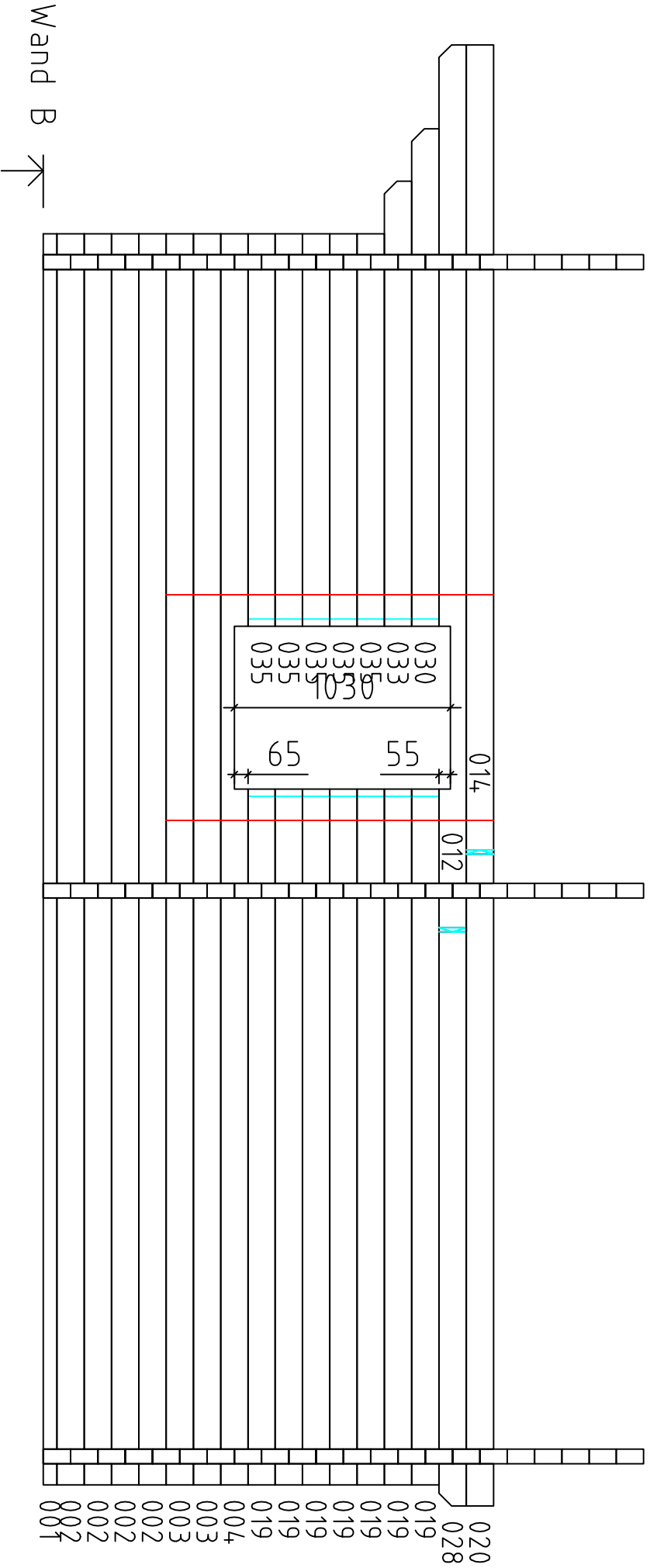

Gotland E // / 70 / 18



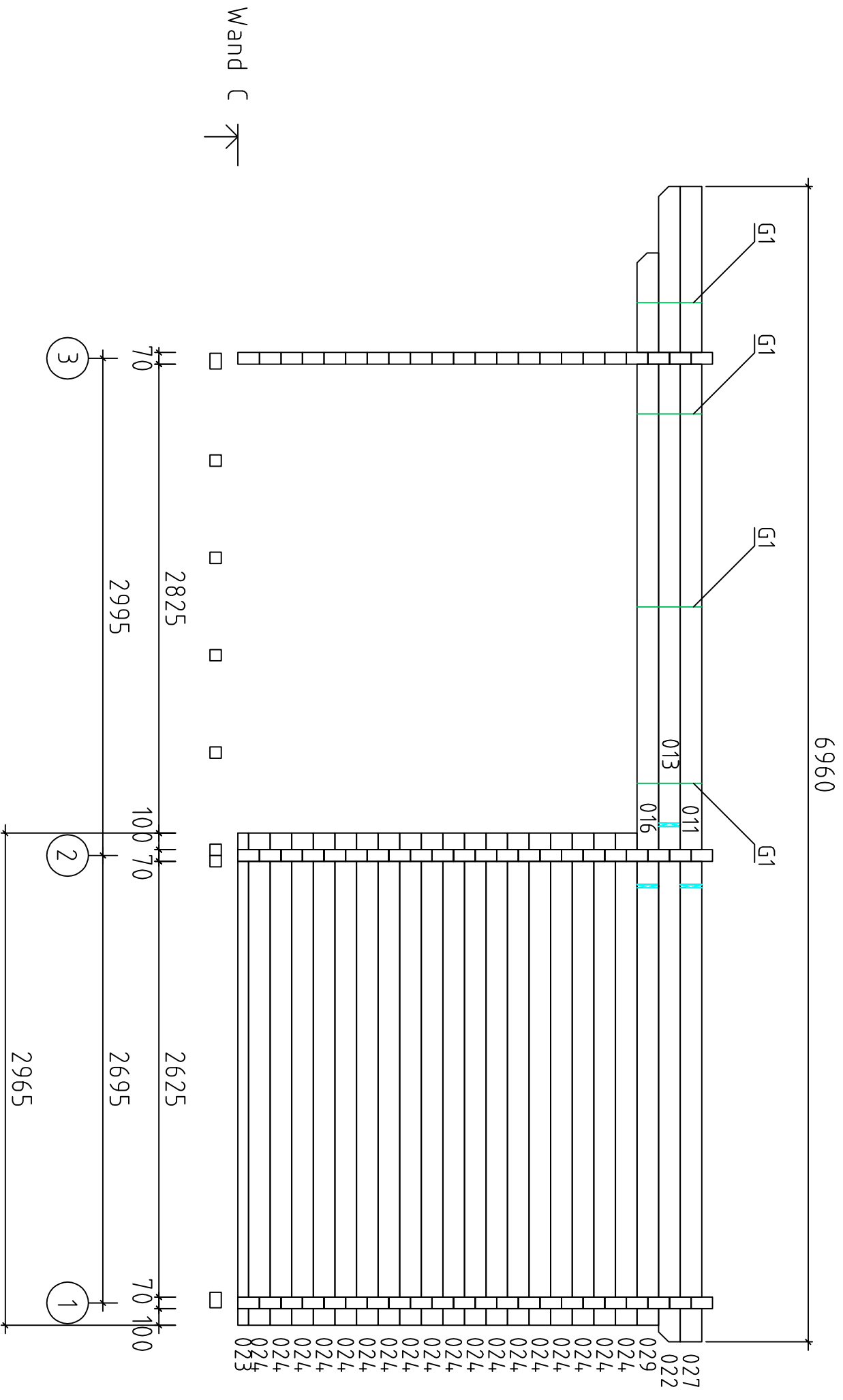







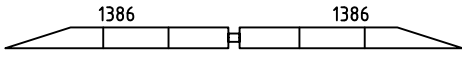
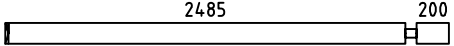
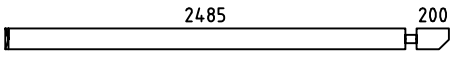
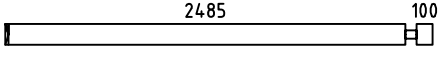
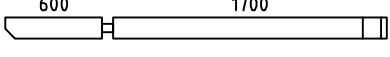
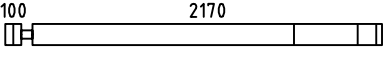
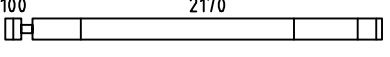
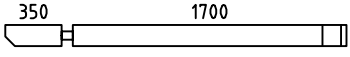
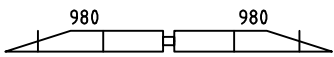
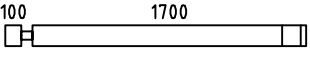
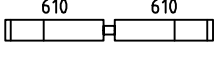
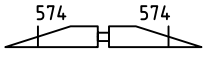
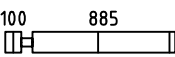
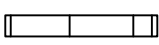
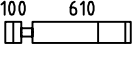
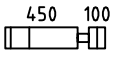

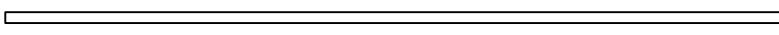
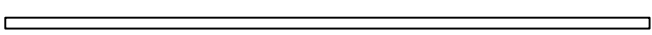
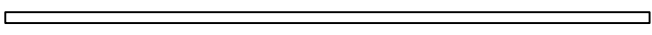
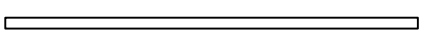
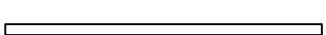
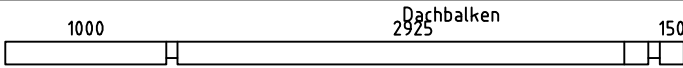
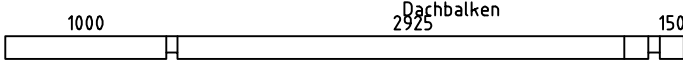

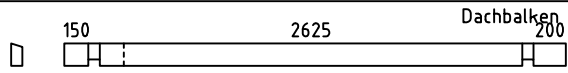
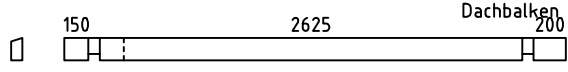

Wand C ↗

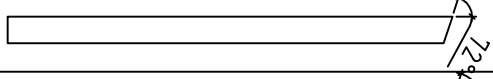
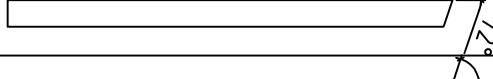
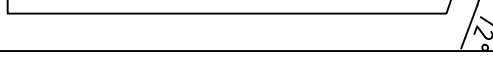
Gotland E /// 70 / 18

Pos	Gotland E ///70/18	ST	F (mm)	L (mm)
001		2	70x65	5960
002		9	70x130	5960
003		3	70x130	5960
004		2	70x130	5960
005		1	70x130	4400
006		2	70x130	4400
007		1	70x130	4400
008		1	70x130	4400
009		3	70x130	4400
010		5	70x130	4400
011		1	70x130	4225
012		2	70x130	4225
013		1	70x130	3855
014		1	70x130	3855
015		1	70x130	3855
016		1	70x130	3825
017		1	70x130	3654
018		2	70x130	3654
019		14	70x130	3315
020		1	70x130	3125
021		1	70x130	3125
022		1	70x130	3125
023		1	70x65	2965
024		18	70x130	2965
025		1	70x130	2842

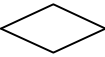
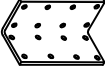
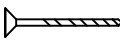
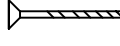
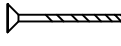
Pos	Gotland E ///70/18	ST	F (mm)	L (mm)	
026		2	70x130	2842	
027		1	70x130	2755	
028		2	70x130	2755	
029		1	70x130	2655	
030		2	70x130	2370	
031		5	70x130	2340	
032		2	70x130	2340	
033		2	70x130	2120	
034		3	70x130	2030	
035		10	70x130	1870	
036		8	70x130	1290	
037		3	70x130	1218	
038		30	70x130	1055	
039		8	70x130	945	
040		16	70x130	780	
041		23	70x130	620	
042		15	70x130	570	
043		3	70x65	406	
AR1	Fundamentbalken 	impr.	2	94x68	5750
AR3	Fundamentbalken 	impr.	2	94x68	4002
AR5	Fundamentbalken 	impr.	6	68x68	4002
AR2	Fundamentbalken 	impr.	1	68x68	2563
AR4	Fundamentbalken 	impr.	8	68x68	1967
PR1	Dachbalken 	2	70x140	4215	
PR3	Dachbalken 	2	70x140	4215	

Pos	Gotland E ///70/18		ST	F (mm)	L (mm)
PR2			2	70x140	3115
PR4			2	70x140	3115
044	Fussbodenbretter		46	90x26	2921
045			46	90x26	2621
046	Dachbretter		158	90x20	2520
047	Abdeckleiste			20x40	35m
048	Giebelbretter		4	20x120	2534
049	Giebelbretter		4	20x90	2556
050	Giebeldeckbretter		4	20x70	2556
051	Giebeldeckbretter		4	20x70	2556
052	Traufenbrett		4	20x90	3480
053	Träger für Deckbretter		6	50x50	2320
054	Giebelsegment		2		
055	Polzen für Deckenbalken M12x80		16		80
G1	Gewindestift12		6	M12	2230
G2			4	M12	410
056					
KMPL.	Vinkel		36	60x60x60	
	Schrauben für Vinkel 4x40		300		
	Schrauben für Fundament 6x130		20		
	Schrauben für dachbretter,dachleisten,abdeckleiste 4,0x50		1000		
	Schrauben für fusboden 4,5x60		600		
	Dübel		270		
	Hitblock	300-400mm			

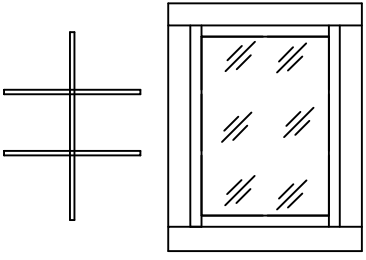
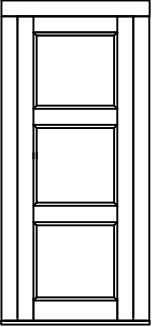
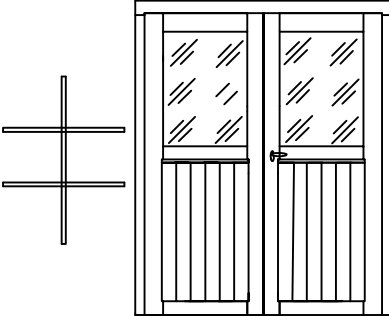
Pos	Gotland E ///70/18	ST	F (mm)	L (mm)				
VBC1	<p style="text-align: center;">Fenster 765x990</p> <p style="text-align: left;">BC</p>  <table border="1" data-bbox="766 246 1209 353"> <tr> <td>Iso</td> <td></td> </tr> <tr> <td></td> <td></td> </tr> </table> <p style="text-align: right;">Tenderleiste 23x23x990=6st. Tenderleiste 23x23x870=4st.</p>	Iso					2R+3L	
Iso								
	<p>Tür 840x1955 (Lengi mõõt)</p>  <p style="text-align: right;">Tenderleiste 23x23x1910=4st.</p>		1R+1L					
	<p style="text-align: left;">AB</p> <p style="text-align: center;">Tür 1420x1955 Lengi mõõt!</p>  <p style="text-align: right;">Tenderleiste 23x23x1910=2st.</p> <table border="1" data-bbox="885 1276 1149 1344"> <tr> <td>Iso</td> <td></td> </tr> <tr> <td></td> <td>kotike 1 kmpl.</td> </tr> </table> <p style="text-align: right;">Pool klaas, pool puit Prosspulgad kaasa</p> <p style="text-align: right;">Roostevabast terasest lävepakk Algab alusraamilt</p>	Iso			kotike 1 kmpl.	1		
Iso								
	kotike 1 kmpl.							